



Z120-H824.11 K1RW2V

High Frequency Spindle

Pneumatic taper change

Identification of HF spindle

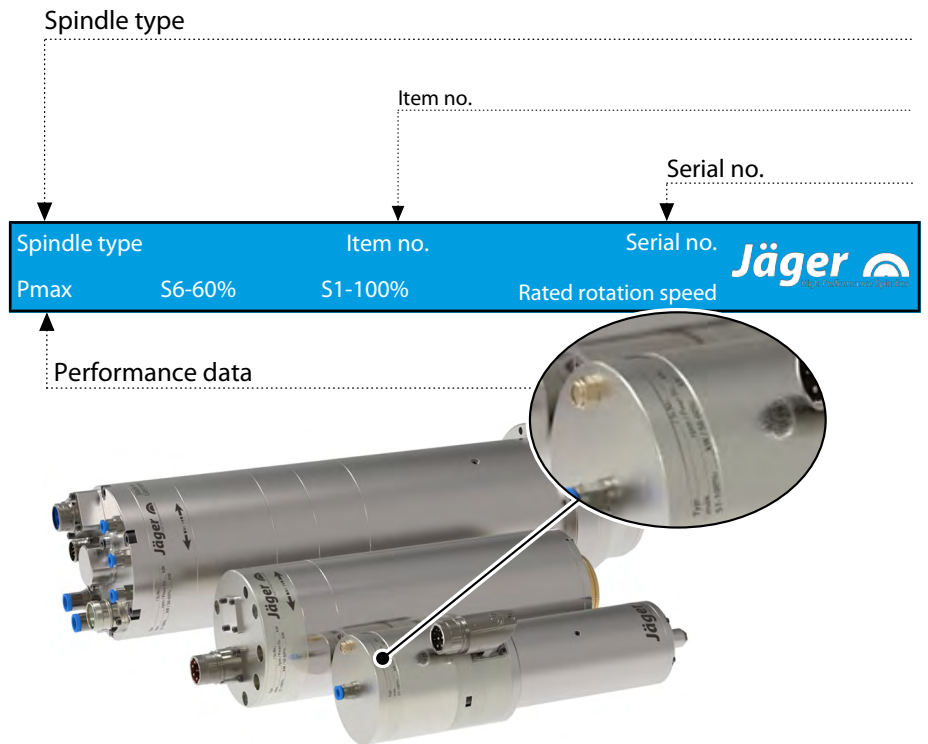

As we always ensure that our HF spindles are at the cutting edge of technological development, we reserve the right to make technical modifications and variations from the exact design described in the manual.

The text in this manual has been compiled with the utmost care. However, **Nakanishi Jaeger GmbH** cannot assume any legal responsibility or liability of any kind for incorrect information and any consequences thereof.

Translations and reproductions – including of extracts – are prohibited without the express written approval of **Nakanishi Jaeger GmbH**.



Contents:

Translation of the original manual

1	Preliminary information	5	6.3	Wiring diagram	23
1.1	Purpose of the manual	5	6.4	Motor protection Pt1000	26
1.2	Explanation of symbols used	5	6.5	Motor protection PTC 130°C	27
2	Transport and packaging	6	6.6	Tool change monitoring	28
2.1	Scope of supply of HF spindle	6	6.7	Speed and position sensor (MiniCoder)	29
2.1.1	Optional accessories	6	6.7.1	Technical Specifications	29
2.1.2	Documentation supplied	6	6.8	Air-borne noise emissions	30
2.2	Packaging of HF spindle	7	7	Operating location	30
3	Designated use	7	8	Installation	31
3.1	Permissible types of machining	7	8.1	Installing the HF spindle	31
3.2	Permissible materials	7	8.2	Diameter of media supply line	32
4	Safety instructions	8	8.3	Cooling water	32
4.1	Safe working	9	8.3.1	Quality of cooling water	32
4.2	Shutdown of HF spindle	10	8.3.2	Setting the cooling	32
4.3	Internal coolant supply	10	8.4	Compressed air	33
4.4	Installation and maintenance	11	8.4.1	Air purity classes (ISO 8573-1)	33
4.5	Modification and repair	11	8.4.2	Setting the sealing air	33
4.6	Improper operation	11	8.4.3	Setting values	34
5	Technical description	12	8.5	Setting the internal coolant supply	35
5.1	Connections of HF spindle	12	9	Commissioning	36
5.2	Electrical connection	13	9.1	Running-in schedule	36
5.3	Cooling	13	9.2	Daily start-up	37
5.4	Sealing air	13	9.3	Shutdown signal	37
5.5	Taper cleaning	13	9.4	Commissioning after storage	37
5.6	Pneumatic tool change	13	10	Tool change	38
5.7	Internal coolant supply	14	10.1	Clockwise and counter-clockwise	38
5.7.1	Cooling lubricant	14	10.2	Pneumatic taper change	39
5.7.2	Filtering the cooling lubricant	15	10.2.1	Automatic hollow shank taper tool clamp	39
5.7.3	Avoiding pressure peaks	15	10.3	Tool changing station (optional accessory)	40
5.8	Leakage	16	10.3.1	pneumatic taper change	40
5.8.1	Internal coolant supply, vertical installation	16	10.3.2	Installing the changing station	40
5.8.2	Internal coolant supply, horizontal installation	17	10.3.3	Maintenance	40
6	Technical Specifications	18	10.4	Workflow	41
6.1	Dimensions	19	10.4.1	Pneumatic workflow	41
6.2	Motor data	20	10.4.2	Electrical workflow	42
6.2.1	Performance Diagram	21	10.4.3	Signals	42
6.2.2	Equivalent circuit diagram data	21	11	Tools for high speed cutting	43
	Parameter	22	12	Maintenance	44

Contents:

Translation of the original manual

12.1	Ball bearings	44
12.2	Daily cleaning	44
12.2.1	Before commencing work	44
12.2.2	With every tool change.....	45
12.2.3	Every time the clamping device is changed	45
12.3	In the case of storage	45
12.4	Weekly maintenance.....	45
12.5	Monthly maintenance	45
12.6	Long periods of storage	46
12.7	Maximum storage time	46
13	Dismantling	47
13.1	Disposal and environmental protection	47
14	Service and repairs	47
14.1	Service partners.....	47
14.2	Malfunctions.....	48
15	Declaration of Incorporation	51

1 Preliminary information

The high frequency spindle (HF spindle) is a high quality precision tool for high speed machining.

1.1 Purpose of the manual

The manual is an important component of the HF spindle.

- Store the manual carefully.
- Make the manual available to all persons who work with the HF spindle.
- Read the documentation supplied in full.
- Before carrying out any work, read the corresponding section of the manual carefully again.

1.2 Explanation of symbols used

To enable quick classification of information, this manual uses visual aids in the form of symbols and text markings.

Notes are marked with a signal word and a colored box:



DANGER
<p>Dangerous situation! Results in serious injury or death. ▶ Measure to avert the danger.</p>



WARNING
<p>Dangerous situation! May result in serious injury or death. ▶ Measure to avert the danger.</p>



CAUTION
<p>Dangerous situation! May result in minor to moderate injury. ▶ Measure to avert the danger.</p>



Note
<p>May result in material damage. This warning symbol is not a warning for personal injury.</p>

Tip
<p>Tips indicate useful information for users.</p>

2 Transport and packaging

Avoid strong vibrations or impacts during transportation, as these could damage the ball bearings of the HF spindle.

- Any damage reduces the accuracy of the HF spindle.
- Any damage restricts the functionality of the HF spindle.
- Any damage shortens the service life of the HF spindle.

2.1 Scope of supply of HF spindle

The following parts are supplied with the HF spindle:

- High Frequency Spindle
- Felt cleaning taper
- Transport packaging
- Check the high frequency spindle for completeness upon delivery.

2.1.1 Optional accessories

Available on request:

- Spindle holder
- Frequency converter
- Chiller
- Collet grease
- Hose connections
- Motor cable
- Control cable
- Further accessories on request.

Only approved accessories have been tested for operational safety and functionality.

- Do not use any other accessories – this may invalidate any warranty claims and compensation claims for damages.
- If the spindle holder is to be produced in-house, it is essential to contact **Nakanishi Jaeger GmbH** before starting production to request the tolerances and production plan for the spindle holder.

2.1.2 Documentation supplied

The documents listed below are supplied with the HF spindle:

- Manual
- The declaration of incorporation is part of the manual.
- Inspection protocol
- Check that the documentation supplied is complete when the spindle is delivered. If necessary, request a new copy.

2.2



Packaging of HF spindle

All transport packaging materials can be recycled in appropriate disposal facilities.

3

Designated use

The HF spindle is an “incomplete machine” in accordance with the Machinery Directive and cannot perform any function independently. The HF spindle can only be operated in conjunction with a machine tool and a frequency converter.

3.1

Permissible types of machining

The HF spindle has been developed only for the following types of machining.

- Cutting
 - Drilling
 - Engraving
 - Grinding
- ➔ Contact **Nakanishi Jaeger GmbH** if other types of machining are required.

3.2

Permissible materials

The HF spindle has been developed only for the following materials.

- Metals (such as alloys, cast metals etc.)
 - Sintered materials
 - Plastics
 - Wood
 - Graphite
 - Stone (marble, etc.)
 - Paper and cardboard
 - Circuit boards
 - Glass and ceramic
- ➔ Contact **Nakanishi Jaeger GmbH** if other materials are to be machined.

4

Safety instructions

The high frequency spindle is a state of the art product and is safe to operate.

However, the HF spindle may pose a risk in the following cases:

- If it is installed by untrained personnel.
- If it is used incorrectly.
- If it is not used in accordance with its intended use.

The high frequency spindle may only be installed, commissioned, and maintained by specialist personnel.

Definition: Specialist personnel are persons who are familiar with the assembly, installation, commissioning, and operation of the product and have the relevant qualifications for their area of activity. The operator must closely control the responsibility, training, and monitoring of these personnel.



DANGER: Due to explosion.

HF spindles are not approved for use in areas at risk of explosion. Use in such areas may result in explosions.

- ▶ Do not use the HF spindle in potentially explosive atmospheres.



DANGER: Due to flying parts.

The HF spindle operates at high speeds and may therefore be flung away by these.

- ▶ Operate the HF spindle only if it is installed in the machine or system in a fixed manner.



Note: Adhere to the limit values.

- ▶ Observe the limit values specified in the technical data.



Note: Take account of the machine.

- ▶ Observe the manual of the machine in which the HF spindle is installed.
- ▶ Observe all safety instructions specified by the machine manufacturer.
- ▶ Ensure that the machine does not cause any hazards (e.g. uncontrolled movements). Do not install the HF spindle in the machine until this has been done.



Note. Do not damage the HF spindle.

- ▶ Any damage reduces the accuracy of the HF spindle.
- ▶ Any damage restricts the functionality of the HF spindle.
- ▶ Any damage shortens the service life of the HF spindle.

4.1

Safe working

Observe all safety instructions set out in the manual, the applicable national accident prevention regulations, and the valid company work, operation, and safety guidelines.



DANGER: Due to flying parts.

Tools that are not clamped correctly will be flung away by the centrifugal forces that occur during machining.

- ▶ Use the full clamping depth of the clamping system.
- ▶ Clamp the tool securely.



DANGER: Due to flying parts.

If the wrong rotational direction is used, the clamping system releases and the tool is flung away.

- ▶ It is essential to adhere to the rotational direction of the HF spindle.



WARNING: Risk of injury due to flying parts.

The HF spindle operates at high speeds which may cause chips to fly out with great force.

- ▶ Never remove the protective devices of the machine or system.
- ▶ Always wear protective goggles during work.

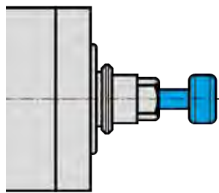

Example of design: Inserting the shank

Note: Ensure functionality.

- ▶ Never operate the HF spindle without a clamped tool shank.

If no tool shank is clamped:

- The clamping system is damaged by the centrifugal forces.
- The clamping system is shifted.
- The balance of the HF spindle is affected.
- The bearing is damaged.

- ➔ Take the relevant measures to protect against splashes and spray according to the type of machining, the type of material being machined, and the type of tool selected.
 - ↪ Observe the manual of the machine in which the HF spindle is installed.
- ➔ Obtain the maximum circumferential speeds of the tools used from the tool supplier.

Single-point tools are not suitable for high speed cutting.

If they are required for production reasons:

- ➔ Only use a balanced tool.
 - ↪ DIN ISO 1940
 - ↪ Balance grade 2,5

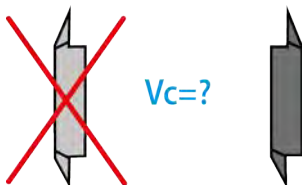

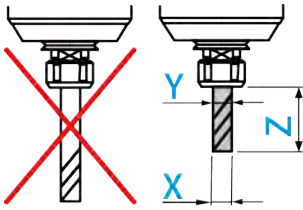

4.2

Shutdown of HF spindle

The procedure for shutting down the high frequency spindle for installation and maintenance work is as follows:

- ➔ Always clamp the tool so that it is as short as possible.
- ➔ Keep the dimension (Z) small.
- ➔ (Y) See section: Technical Specifications [▶ 18].

If the HF spindle is being shut down to be cleaned:

- ➔ Reconnect only the sealing air and the taper cleaning air.

Tip: Forward the data to the controller.

- ▶ Use the option on the frequency converter of detecting the shutdown signal from the shaft and forwarding this to the machine controller for evaluation.

4.3



Internal coolant supply

DANGER: Due to explosion.

Flammable flow media or hydrocarbons may ignite and trigger explosions.

- ▶ Ensure that no flammable flow media are used.
- ▶ Ensure that no hydrocarbons are used.

Exception:

Heat-transfer oils within the permissible temperature range.

- ▶ Note the safety data sheet of the oil that is used.



WARNING: Risk of injury due to flying parts.

If excessive pressure is applied to the internal coolant supply, connection cables may fly off.

- ▶ Do not connect the internal coolant supply to a pipe system with an excessive level of pressure.



WARNING: Risk of burns.

If the flow media exceed the maximum permissible temperature, the seals may be damaged. This causes the internal coolant supply to leak and hot media may escape.

- ▶ Do not route flow media with excessive temperatures through the internal coolant supply.

CAUTION: Risk of injury due to emerging medium.

During work on the internal coolant supply, the medium may come into contact with skin or eyes.

- ▶ Observe the safety instructions for the flow medium that is used.

CAUTION: Risk of injury due to emerging medium.

If unsuitable hoses are used, they may become porous or burst.

- ▶ To connect the internal coolant supply to the machine, choose suitable hoses with specifications that match the application.
- ▶ Use hoses that are approved for the medium.
- ▶ Use hoses that are approved for the maximum system pressure of the machine.
- ▶ Use hoses that are approved for the maximum temperature of the medium.

4.4 Installation and maintenance

- ➞ Carry out installation, cleaning, and maintenance work only after shutting down the HF spindle and after the shaft has come to a standstill.
- ➞ Install all safety and protective devices of the machine immediately after completing work.

4.5 Modification and repair

Modifications or alterations to the HF spindle are only permitted after prior consultation with **Nakanishi Jaeger GmbH**.

Only the service partners listed in the “Service and repair [▶ 47]” section are authorized to open and repair the HF spindle.

Only approved accessories have been tested for operational safety and functionality.

4.6 Improper operation

The high frequency spindle is only safe to operate for its designated use.

- ➞ Observe the safety instructions in all sections of the manual to prevent hazards to persons, the environment, the machine, or the HF spindle itself.

Failure to observe the safety instructions may invalidate any warranty claims and compensation claims for damages.

5 **Technical description**
5.1 **Connections of HF spindle**

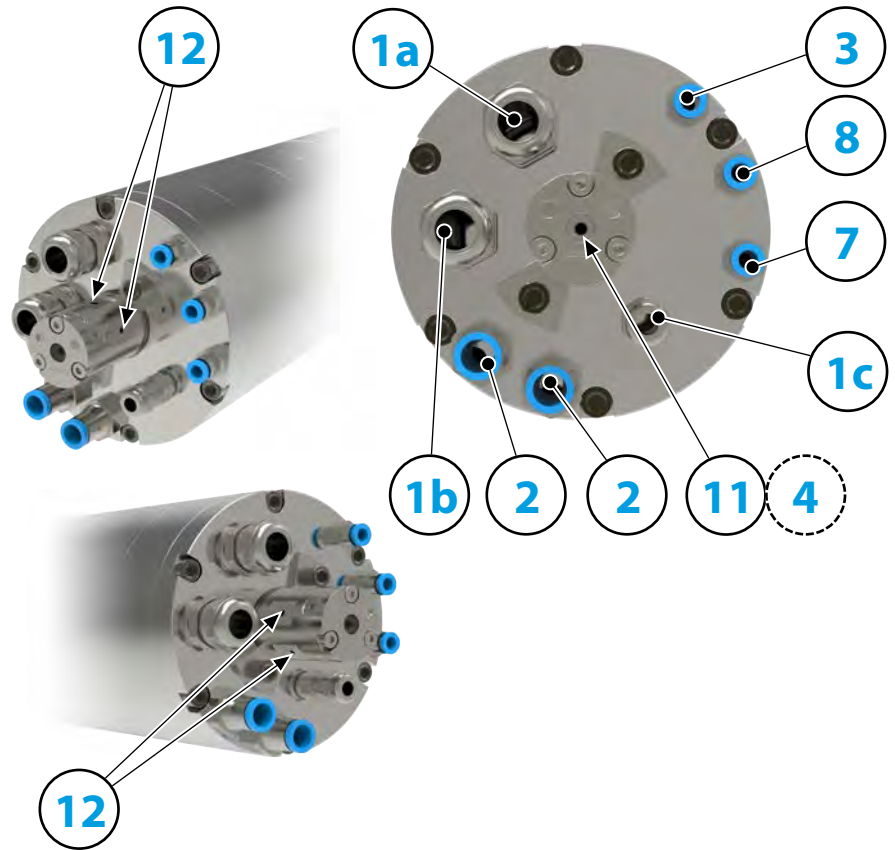

1a	Electrical connection for: motor phases	
1b	Electrical connection for: Tool taper monitoring, PTC, Pt1000	
1c	Electrical connection for: Vector control	
2	Cooling water	G 1/4"
3	Sealing air	G 1/8"
4	Taper cleaning	G 1/8"
7	Pneumatics for tool change (cylinder forward)	G 1/8"
8	Pneumatics for tool change (cylinder back)	G 1/8"
11	Internal coolant supply	G 1/8"
12a	Leakage	M7
12b	Leakage	M7

5.2 Electrical connection

The HF spindle may only be operated with a frequency converter (FC).

- ➔ Check whether the current, voltage, and frequency data of the HF spindle match the raw data for the frequency converter.
- ➔ Use a motor supply line that is as short as possible.
- ➔ Adjust the speed of the HF spindle using the FC.
- ➔ Refer to the frequency converter manual for further information.

The FC detects the following operating states of the HF spindle, depending on the version:

- HF spindle rotating.
- HF spindle too hot.
- HF spindle at a standstill, etc.

The FC forwards the operating states of the HF spindle to the machine controller.

5.3 Cooling

Liquid cooling keeps the HF spindle at a constant temperature during operation.



Note: Extension of the service life through heat dissipation.

Heat is produced during operation of the HF spindle. The temperature of the HF spindle should not exceed + 45° C as this shortens the service life of the bearing.

- ▶ Check the temperature of the HF spindle on the housing.

5.4 Sealing air

For guidelines on air quality, see "Air purity classes (ISO 8573-1) [▶ 33]" section.

The sealing air prevents foreign bodies such as chips and liquids (e.g. emulsions) from entering the HF spindle.

- ➔ Check that air escapes at the front between the housing and the rotating parts of the HF spindle.

5.5 Taper cleaning

For guidelines on air quality, see "Air purity classes (ISO 8573-1) [▶ 33]" section.

Taper cleaning prevents chips and liquids from entering the shaft during a tool change and causing contamination and damage to the inner taper and the clamping system.

5.6 Pneumatic tool change

For guidelines on air quality, see "Air purity classes (ISO 8573-1) [▶ 33]" section.

The tool change or tool taper change is performed pneumatically.

During this, a mechanism is operated inside the HF spindle which clamps, releases, or ejects the tool taper or collet.

5.7

Internal coolant supply

The internal coolant supply cools the tool and the HF spindle.

The tool coolant is routed internally through the HF spindle and tool, and emerges at the interface of the clamped tool. The coolant lubricates the tool at the same time.

Note: Unsuitable tool.

Tools without an internal hole are not suitable for internal coolant supply.

- ▶ It is essential to switch off the internal coolant supply if tools without an internal hole are being used for production reasons.

If this is not done, the HF spindle will be damaged or destroyed.

- ➞ Only use tools and tool holders that are suitable for internal coolant supply.
- ➞ Make sure that the cooling lubricant used conforms to the current specifications in legislation and from the trade associations.
- ➞ Make sure that compressed air is not applied to the internal coolant supply in the case of a rotating shaft. Otherwise, the sealing surfaces of the internal coolant supply will be damaged.

5.7.1



Cooling lubricant

CAUTION: Danger due to hydraulic oil spraying out.

If the internal coolant supply is used for hydraulic oil, the internal coolant supply may be damaged and hydraulic oil may be sprayed out at high pressure.

- ▶ Do not use hydraulic oils.

- ➞ Only use cooling lubricants that comply with the following guidelines:

Cutting oil

Temperature of the medium	min. +3°C
Ambient temperature	min. +3°C

5.7.2 Filtering the cooling lubricant

Unfiltered flow media with a particle size in excess of 60 µm lead to increased wear.

- ➔ Use a filter upstream of the internal coolant supply that filters out particles that are bigger than 60 µm from the medium.

The greater the number of particles in the flow medium, the greater the wear on the internal coolant supply.

- ➔ Ensure that the residual dirt load complies with the following specifications:

- ↳ max. 100 mg/l

- ↳ Aluminum machining: max. 50 mg/l.

- ➔ Use media of the following classes:

- ↳ Class 5 according to ISO 4406:1999 code 17/15/12

- ↳ or class 8 according to NAS 1638

5.7.3 Avoiding pressure peaks

Pressure peaks mainly occur when an incompressible medium (e.g. cooling lubricant) collides at high speed with a closed or almost closed hole. This impact may cause the pressure to increase to many times the permitted pressure.

- ➔ Select the duty cycle of the valve so that the peaks in pressure that occur not exceed the normally permitted operating pressure.

Closing valves may also cause excessive pressure (fluid hammer).

Excessive pressures may also occur when pressure is additionally applied to an incompressible medium (e.g. cooling lubricant) in a closed space due to a stroke motion.

- ➔ Remedy: ventilation.

5.8



Leakage

Note: Damage to the HF spindle due to leakage.

Cooling lubricant may enter the HF spindle through the bearing of the internal coolant supply and destroy it:

- If the internal coolant supply is operated in the lower pressure range.
- If the pressure of the cooling medium builds up slowly.
- ▶ Use leakage monitoring to protect the HF spindle from damage.

If pressure is applied to the internal coolant supply, the seal ring pair inside the internal coolant supply closes.

If the pressure is deactivated, the mechanical seal opens. The leakage quantity that emerges is discharged through a separate line by means of the relief hole.

The leakage quantity depends on the following factors:

- Cooling lubricant and its viscosity.
- Installation position of the internal coolant supply.
- Routing of the supply line.
- Position of the cooling lubricant valve and of the non-return valve and/or 3/2-way valve.

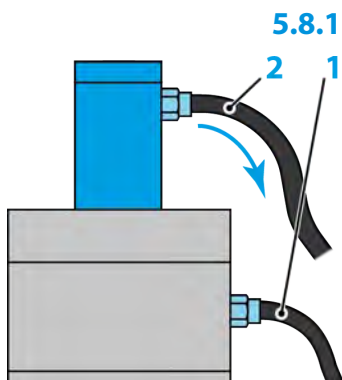

Example of design: Leakage

Internal coolant supply, vertical installation

Leakage	Screw-in depth
1 High Frequency Spindle	max. 6 mm
2 Internal coolant supply	max. 6 mm

- ➔ Remove the sealing plugs that protect the connections against damage and contamination during transportation.
- ➔ Instead of these sealing plugs, install the appropriate hose fittings.
- ➔ Install the corresponding hoses in the hose fittings
- ➔ Route the leakage hose with a falling gradient so that the leakage can be discharged.
 - ↪ Angle: at least 15°.
- ➔ Route away the leak to avoid backing up.

5.8.2

Internal coolant supply, horizontal installation

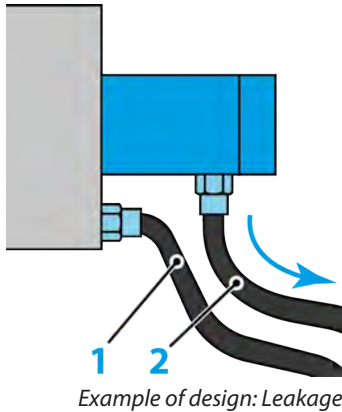

Leakage		Screw-in depth
1	High Frequency Spindle	max. 6 mm
2	Internal coolant supply	max. 6 mm

- ➔ Position the HF spindle so that all leakage lines can always be connected to the relief holes in the 6 o'clock position (at the lowest point).
- ➔ Remove the sealing plugs that protect the connections against damage and contamination during transportation.
- ➔ Instead of these sealing plugs, install the appropriate hose fittings.
- ➔ Install the corresponding hoses in the hose fittings
- ➔ Route the leakage hose with a falling gradient so that the leakage can be discharged.
 - ↳ Angle: at least 15°.
- ➔ Route away the leak to avoid backing up.

6

Technical Specifications

Bearings

Hybrid ball bearing (pcs)	4
Lifetime lubricated	maintenance free

Power values

Liquid cooled

	Pmax./5s	S6-60%	S1-100%	
Rated power	26	20	18	[kW]
Torque	21,4	15,5	13,6	[Nm]
Voltage	380	380	380	[V]
Current	55	43,8	39,7	[A]

Motor data

Motor technology	3-phase asynchronous drive (no brushes or sensors)
Frequency	800 Hz
Motor poles (pairs)	2
Rated rotation speed	24.000 rpm
Acceleration/braking value Per second	10 000 rpm (other values by consultation)

Characteristics

Speed sensor	Vector control
Toothed wheel	Teeth = 256 Module = 0,3
Motor protection	PTC 130°C Pt1000
Housing	Stainless steel
Housing diameter	120 mm
Cooling	Liquid cooled
Ambient temperature	+ 10°C ... + 45°C
Sealing air	
Protection category (sealing air turned on)	IP54
Taper cleaning	
Internal coolant supply	
Internal coolant supply	< 80 bar < 10 l/min
Tool change	Pneumatic taper change
Tool Holder	HSK-E 50
Tool change monitoring	inductive
3 positions	clamped, unclamped, ejected

Clamping range up to	20 mm
Clockwise and anticlockwise	
Coupler plug	5-pin (ECTA 133) (motor phases) 12-pin (ECTA 133) + 17-pin (sensors)
Weight	~ 27 kg
Inner taper run out	< 1 μ
Axial run-out	< 1 μ

6.1 Dimensions

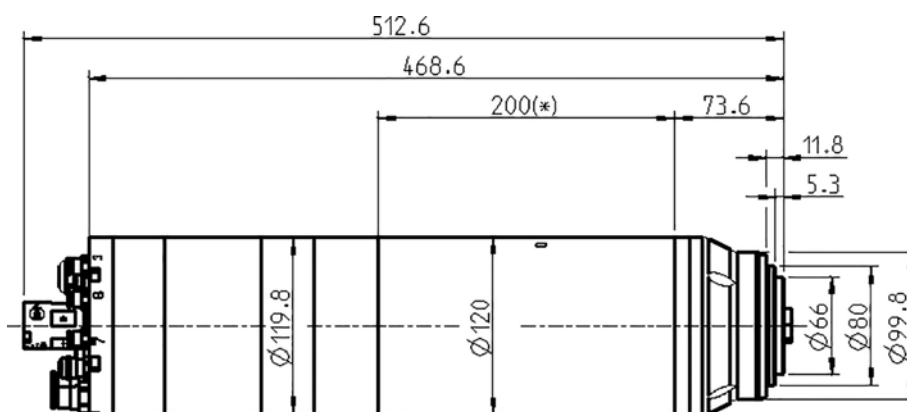

(*) = Clamping range

6.2

The power values (S1, S6, S2) are valid for sinusoidal currents and voltages.

The power values of the HF spindle are dependent on the frequency converter used and may vary from the indicated values.

Motor data

Spindle characteristic curve	9110
Motor technology	AC Motor
Motor type	ACM 90/62/130-4E
Rated power	18 kW
Rated rotation speed	24.000 rpm
Cooling	Liquid cooled
Motor protection	PTC 130° C Pt1000
Winding resistance (phase-phase)	0,184 Ω
Power dissipation	2.353 W – max. (S1)

Measured values: S1-100%

Rated rotation speed	1 800	5 000	10 000	12 000	15 000	24 000	rpm
Speed	1 447	4 596	9 605	11 612	14 422	23 114	rpm
Frequency	60	167	333	400	500	800	Hz
Rated power	1,87	6,5	13,2	15,7	18	16,7	kW
Torque	12,33	13,59	13,22	13,01	12,04	7,07	Nm
Voltage	70	170	320	380	380	380	V
Current	38,1	39,7	38,9	38,5	38	35,2	A
cos φ	0,76	0,73	0,72	0,72	0,82	0,84	

Measured values: S6-60%

Rated rotation speed	1 800	5 000	10 000	12 000	15 000	24 000	rpm
Speed	1 425	4 534	9 543	11 543	14 376	23 005	rpm
Frequency	60	167	333	400	500	800	Hz
Rated power	2,02	7,34	14,98	17,85	19,14	17,8	kW
Torque	13,58	15,5	15,07	14,86	12,83	7,58	Nm
Voltage	72	172	322	380	380	380	V
Current	41,2	43,8	43	42,6	40,9	38,6	A
cos φ	0,77	0,75	0,74	0,74	0,81	0,83	

Measured values: S2-Pmax./5 s

Rated rotation speed	1 800	5 000	10 000	12 000	15 000	24 000	rpm
Speed	1 307	4 499	9 479	11 464	14 267	22 702	rpm
Frequency	60	167	333	400	500	800	Hz
Rated power	2,93	9,91	20,49	24,54	25,8	23,64	kW
Torque	21,37	21,07	20,72	20,53	17,39	10,13	Nm
Voltage	75	175	325	380	380	380	V
Current	55	55	55	55	55	55	A
cos φ	0,85	0,8	0,79	0,79	0,83	0,8	

Note on operation with static frequency converters:

For operation with a frequency converter, the effective fundamental voltage must correspond to the specified motor voltage.

The measured currents may be greater than the specified values due to the harmonic content.

6.2.1 Performance Diagram

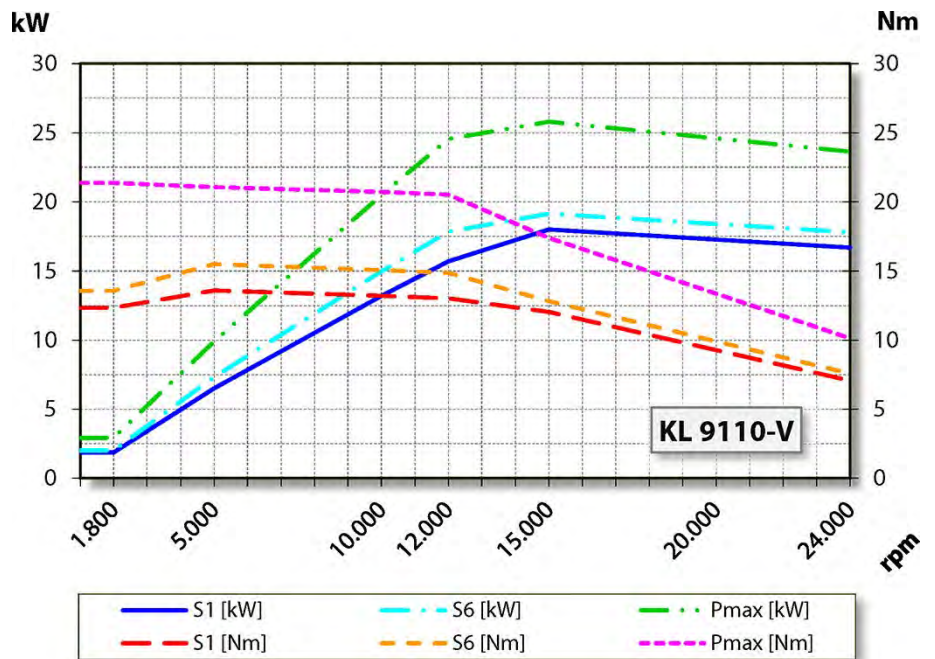

6.2.2 Equivalent circuit diagram data

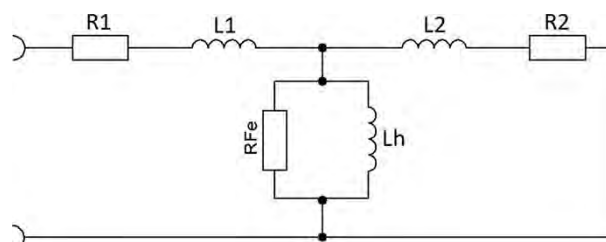



Note: Damage due to incorrect performance data.

The values of the parameters relate exclusively to the motor.

► HF spindle values: See tables S1-100%, S6-60% and S2-Pmax.

Parameter*	Meaning	Value	Unit
p0304	Rated voltage (phase-phase)	380	Vrms
p0305	Rated current	38,5	Arms
p0307	Rated power	15,7	kW
p0308	Rated power factor	0,72	cos φ
p0310	Rated frequency	400	Hz
p0311	Rated speed	12.000	rpm
---	Rated power loss	2.353	W
---	Rated rotation speed	24.000	rpm
p0312	Rated torque	13,008	Nm
p0314	Motor poles (pairs)	2	---
p0320	Rated magnetization current	21,5	Arms
p0322	Maximum speed	24.000	rpm
p0326	Stalling torque correction factor	100	%
p0335	Cooling type	Liquid cooled	
p0341	Moment of inertia	0,003247	kgm ²
p0348	Field weakening operating speed VDC=600V	13.398	rpm
p0350	Stator resistance, cold (strand)	0,184	Ω
p0353	Series inductance (strand)	0	mH
p0354	Rotor resistance, cold	0,156	Ω
p0356	Stator stray inductance	0,282	mH
p0358	Rotor stray inductance	0,325	mH
p0360	Main inductance	3,596	mH
p0604	Motor temperature warning threshold	120	°C
p0605	Motor temperature fault threshold	130	°C
p0640	Current limit	55	Arms
p1800	Pulse frequency	16	kHz
---	DC link voltage	560	VDC
---	Series capacitance		μF
---	Maximum voltage		V
---	Idle reduction		%
---	Stator stray reactance X1		Ω
---	Rotor stray reactance X2		Ω
---	Main field reactance Xh		Ω

(*) Parameters for Siemens SINAMICS 120

6.3 Wiring diagram

Note: Do not change the ex-works configuration.

Any change may cause overvoltage on the electrical components (e.g. PTC, differential magneto resistor).

	1	2	3	4	5	6
--	---	---	---	---	---	---

Gerätestecker FS5 (S11)
spindle plug FS5 (S11)

Spindel

Achtung
Pins nach dem crimpen zusätzlich verlöten
attention
solder pins in addition to the crimp

Motorvarianten			
AC 6.01-2	* 8.2/11-4pol	**3/7-4pol	***4/7-2pol
AC 7.01-2	* 8.1/11-4pol		***2/7-2pol
AC 8.01-4			

Kundenseite
customer side

phase U
phase V
PE Schutzleiter
protective earth

Kundenseite
customer side

Rückseite
back side

Datum	03.03.17		Zeichn.Nr.:	29022970	Projekt Nr.:	
Bearb.	Perschewski		Version Nr.:		Blatt 1	
Gepr.			Pinbelegung FS5 (S11) ECTA		von 1 Bl.	
Norm	DIN 81346	<small>Übersetzungen, Vervielfältigungen und die Weitergabe an Dritte, auch nur auszugsweise, ist ohne schriftliche Genehmigung der Fa. Nakanishi Jaeger GmbH untersagt</small>				

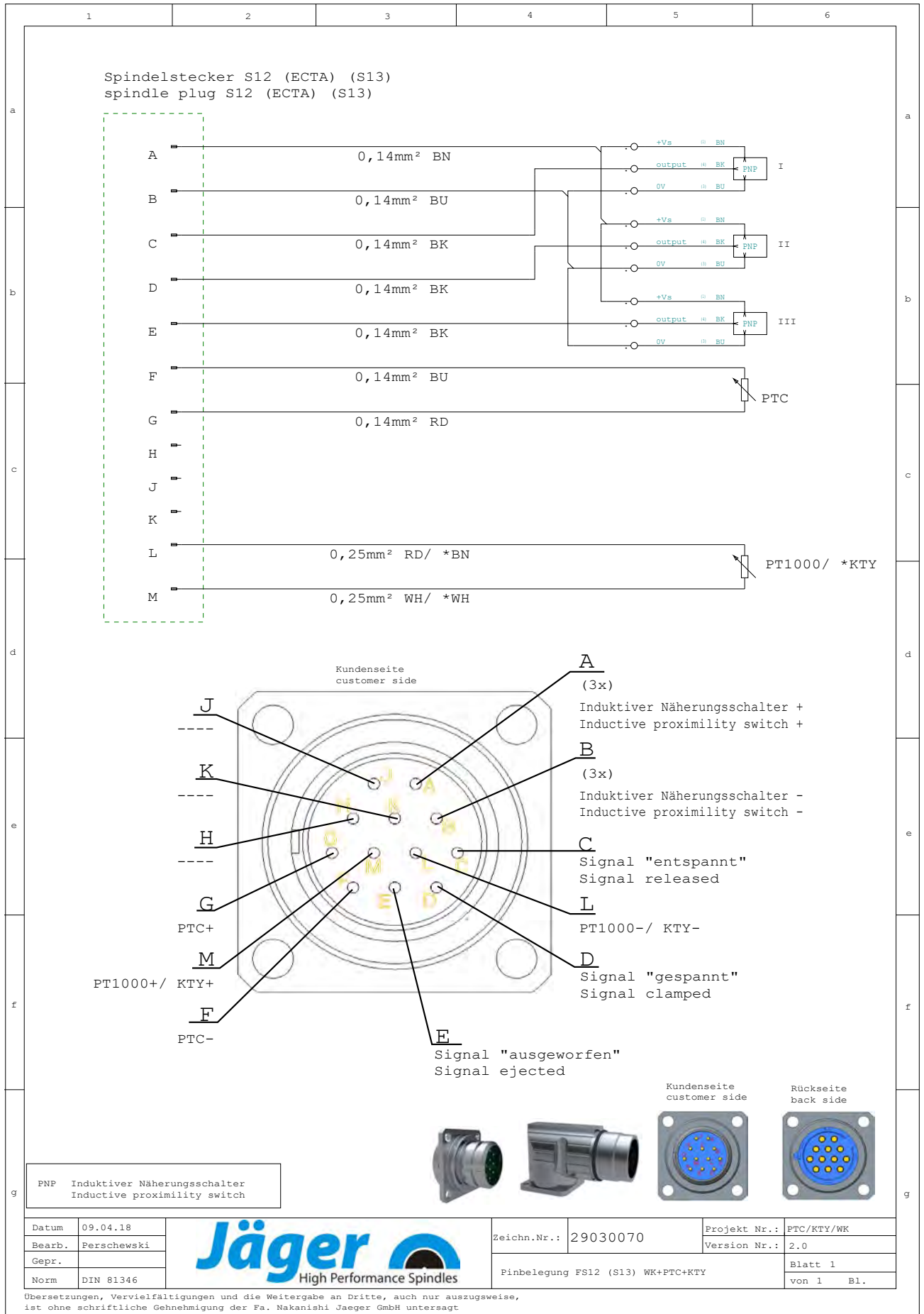

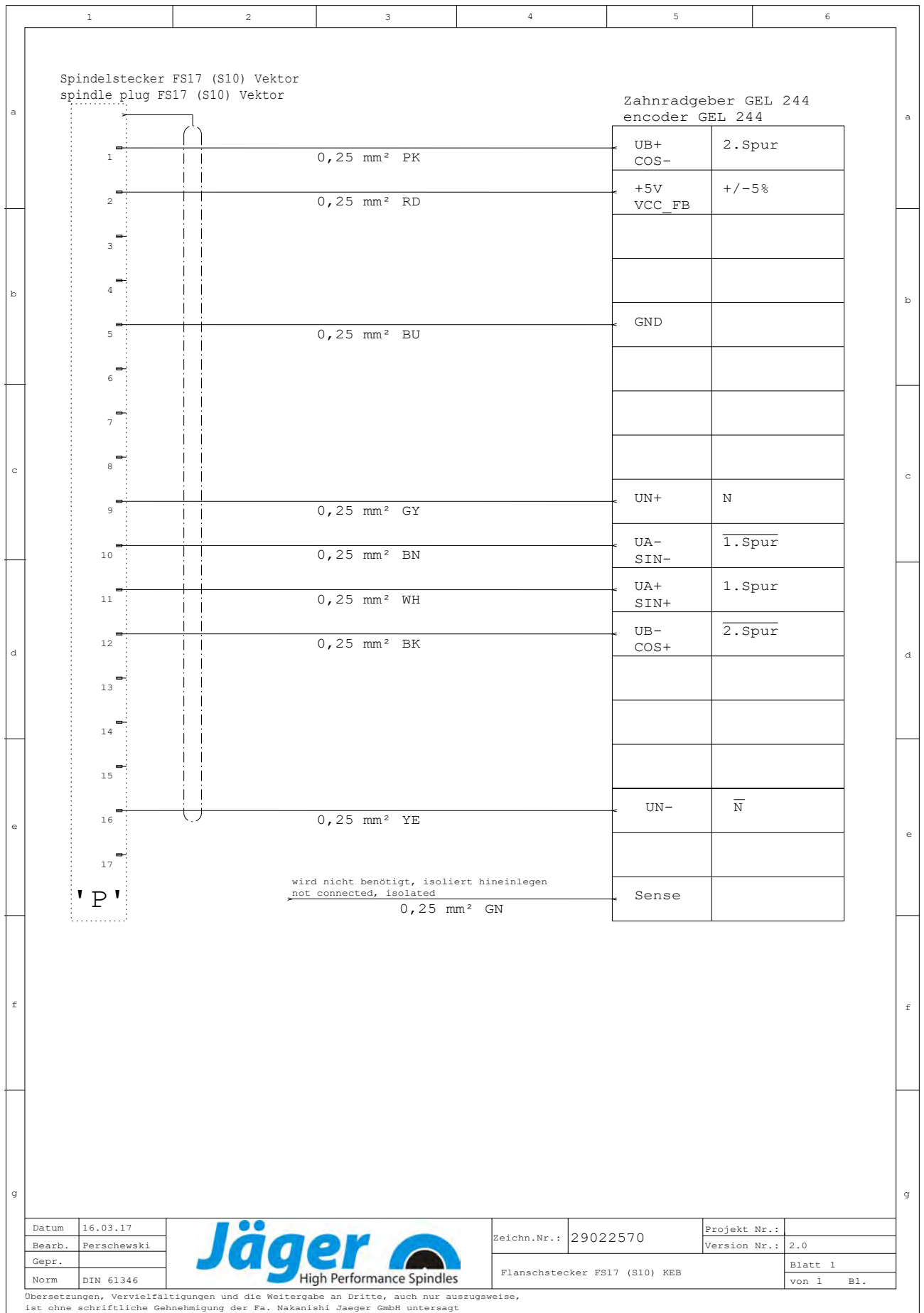

Datum	16.03.17
Bearb.	Perschewski
Gepr.	
Norm	DIN 61346



Zeichn.Nr.:	29022570	Projekt Nr.:	
Flanschstecker FS17 (S10) KEB		Version Nr.:	2.0
		Blatt 1	
		von 1	Bl.

Übersetzungen, Vervielfältigungen und die Weitergabe an Dritte, auch nur auszugsweise, ist ohne schriftliche Genehmigung der Fa. Nakanishi Jaeger GmbH untersagt

6.4

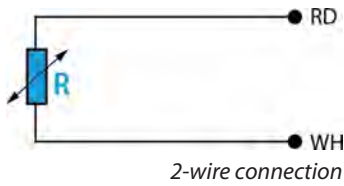

Motor protection Pt1000

Platinum temperature sensor

Design according to:

- DIN EN 60751
- Accuracy class B

Technical Specifications

Temperature/resistance correlation (series of basic values)

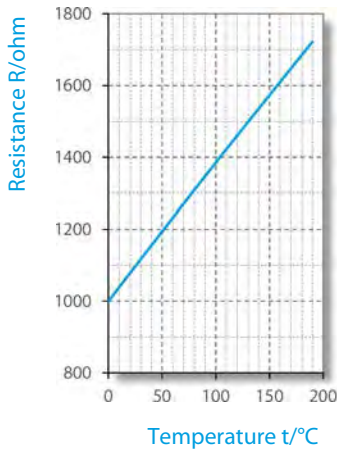

$t_{90}/^{\circ}\text{C}$	(*) Resistance at temperature $t_{90}/^{\circ}\text{C}$ [Ω]									
	0	1	2	3	4	5	6	7	8	9
0	1000	1004	1008	1012	1016	1020	1023	1027	1031	1035
10	1039	1043	1047	1051	1055	1059	1062	1066	1070	1074
20	1078	1082	1086	1090	1094	1097	1101	1105	1109	1113
30	1117	1121	1125	1128	1132	1136	1140	1144	1148	1152
40	1155	1159	1163	1167	1171	1175	1179	1182	1186	1190
50	1194	1198	1202	1206	1209	1213	1217	1221	1225	1229
60	1232	1236	1240	1244	1248	1252	1255	1259	1263	1267
70	1271	1275	1278	1282	1286	1290	1294	1298	1301	1305
80	1309	1313	1317	1320	1324	1328	1332	1336	1340	1343
90	1347	1351	1355	1359	1362	1366	1370	1374	1378	1381
100	1385	1389	1393	1396	1400	1404	1408	1412	1415	1419
110	1423	1427	1431	1434	1438	1442	1446	1449	1453	1457
120	1461	1464	1468	1472	1476	1480	1483	1487	1491	1495
130	1498	1502	1506	1510	1513	1517	1521	1525	1528	1532
140	1536	1540	1543	1547	1551	1555	1558	1562	1566	1570
150	1573	1577	1581	1585	1588	1592	1596	1599	1603	1607
160	1611	1614	1618	1622	1625	1629	1633	1637	1640	1644
170	1648	1651	1655	1659	1663	1666	1670	1674	1677	1681
180	1685	1689	1692	1696	1700	1703	1707	1711	1714	1718

(*) Rounded values

6.5 Motor protection PTC 130°C

PTC thermistor with protective insulation

Characteristic curves for rated response temperatures 90°C to 160°C in accordance with DIN VDE V 0898-1-401.

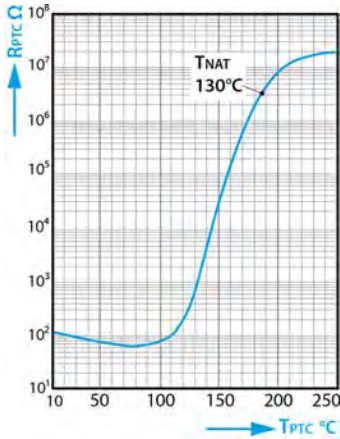

Positive temperature coefficient thermistor resistance (R_{PTC}) according to the positive temperature coefficient thermistor temperature (T_{PTC}) (small-signal resistance).

Technical Specifications

Type	M135		
Max. operating voltage	($T_A = 0 \dots 40^\circ\text{C}$)	V_{\max^*}	30 V
Max. measuring voltage	($T_A - 25 \text{ K} \dots T_{\text{NAT}} + 15 \text{ K}$)	$V_{\text{Meas, max}}$	7.5 V
Nominal resistance	($V_{\text{PTC}} \leq 2.5 \text{ V}$)	RN	$\leq 250 \Omega$
Insulation test voltage		V_{is}	3 kV~
Response time		t_a	< 2.5 s
Operating temperature range	($V=0$)	T_{op}	-25/+180°C

Resistance values

$T_{\text{NAT}} \pm \Delta T$	$R(T_{\text{NAT}} - \Delta T)$ ($V_{\text{PTC}} \leq 2.5 \text{ V}$)	$R(T_{\text{NAT}} - \Delta T)$ ($V_{\text{PTC}} \leq 2.5 \text{ V}$)	$R(T_{\text{NAT}} + 15 \text{ K})$ ($V_{\text{PTC}} \leq 7.5 \text{ V}$)	$R(T_{\text{NAT}} + 23 \text{ K})$ ($V_{\text{PTC}} \leq 2.5 \text{ V}$)
$130 \pm 5^\circ\text{C}$	$\leq 550 \Omega$	$\geq 1330 \Omega$	$\geq 4 \text{ k}\Omega$	----

6.6 Tool change monitoring

Tool taper monitoring indicates the readiness status of the HF spindle to the operator and forwards the corresponding signal to the machine controller.

- ☐ Tool taper monitoring using inductive proximity switch.

Signals

Tool clamped	Tool released	Tool ejected
HF spindle	HF spindle	HF spindle
↓	↓	↓
Ready to operate	Not ready to operate	Not ready to operate

Operating voltage range:
10-30 VDC (UL – Class 2)
Switching distance: Sn 2.0 mm
Short-circuit and reverse-polarity resistant.

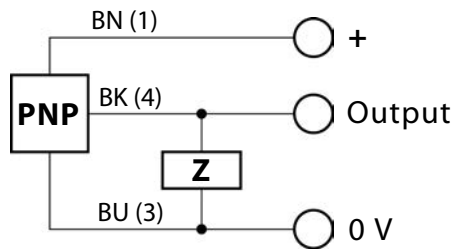

BN = brown
BK = black
BU = blue
NO = Normally open

6.7

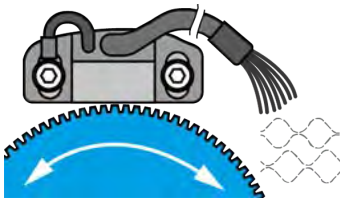

Example of design: toothed wheel

Speed and position sensor (MiniCoder)

The MiniCoder scans a target wheel (toothed wheel) made from ferromagnetic material. The magnetic field of the built-in encoder is modulated by the moving target wheel.

- The sensor detects the change in magnetic field and converts this into a sinusoidal output signal.

6.7.1

Technical Specifications

Output level	1 V _{SS} as differential signal
Output signal	2 sinusoidal signals offset by 90° and their inverse signals; short-circuit-proof; Option: reference pulse
Output frequency	0 ... 200 kHz for a line capacity of 5 nF
Offset (static)	± 20 mV
Amplitude tolerance	-20% ... +10%
Amplitude synchronization USp1/USp2	0.9 ... 1.1
Supply voltage UB	5 V _{DC} ±5%
Power consumption without load	≤ 0.3 W
Cable length	max. 100 m (note voltage drop via supply line)
Connection	9-core cable Core cross-section: 0.15 mm ² Outer diameter: 5 -0.3 mm, min. bending radius: 25 mm additionally routed shielded cable for grounding near to sensor

6.8



Air-borne noise emissions

CAUTION: Noise has an impact on health.

▶ Only operate the HF spindle if you are wearing hearing protection.

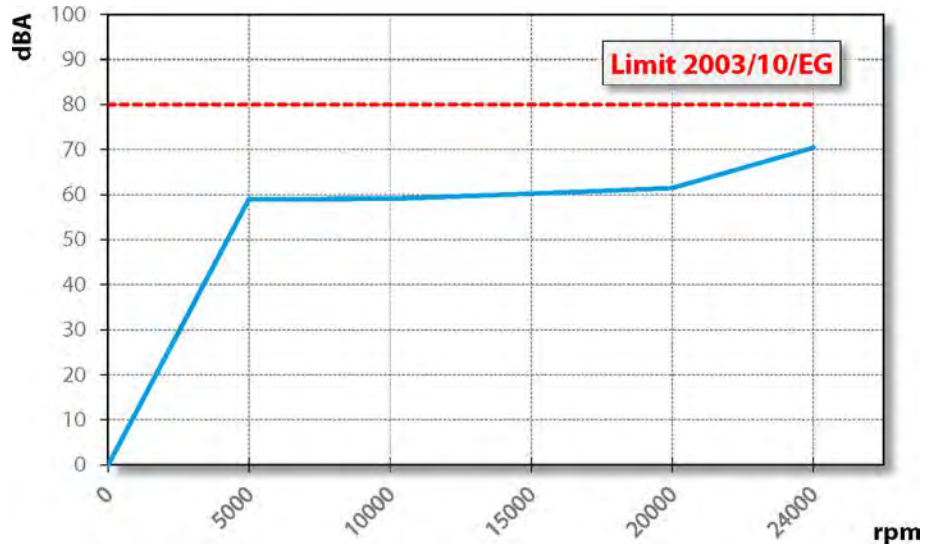

7



Operating location

DANGER: Due to flying parts.

If the HF spindle is incorrectly attached, it may come loose during operation and be flung away by the forces that occur.

▶ Clamp the HF spindle firmly.



WARNING: Risk of injury due to flying parts.

The HF spindle operates at high speeds which may cause chips to fly out with great force.

- ▶ Never remove the protective devices of the machine or system.
- ▶ Always wear protective goggles during work.

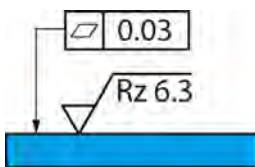

Example of design: Mounting surface

Note the following points before installing the HF spindle:

- ➔ Make sure that the correct spindle holder for the HF spindle is fitted in the machine.
- ➔ Check the connecting hoses for damage.
- ➔ Check the connecting cables for damage.
- ➔ Only use undamaged hoses and cables.
- ➔ Do not allow the HF spindle to run in the vicinity of a heat source.

8

Installation**Before installation:**

- ➔ Check the HF spindle for damage and ensure that it is complete.

If the HF spindle has been stored for a long period:

- ➔ Carry out all steps in the Commissioning after storage section.

8.1

Installing the HF spindle

Complete the following steps in sequence to install the HF spindle:

- ➔ Remove the sealing plugs that protect the connections against damage and contamination during transportation.
- ➔ Instead of these sealing plugs, install the appropriate hose fittings.
- ➔ Install the corresponding hoses in the hose fittings
- ➔ Make sure that the connections are flexible and free of strain.
- ➔ Seal all connections for compressed air axially in relation to the tightening direction.
- ➔ Seal all connections for cooling water axially in relation to the tightening direction.
- ➔ If the HF spindle is equipped with sealing air:
 - ✎ Make sure that no air flow can occur in the bearing area.
 - ✎ Always use sealed cable boxes when connecting electrical lines.
- ➔ Mount the HF spindle on the machine.
- ➔ Connect the hoses to the connection of the respective media.
- ➔ Remove the protective cap that protects the shaft against damage and contamination during transportation.
- ➔ Connect the connector of the operating connection lines to the relevant connection of the HF spindle and to the frequency converter.
- ➔ Lock the connectors.

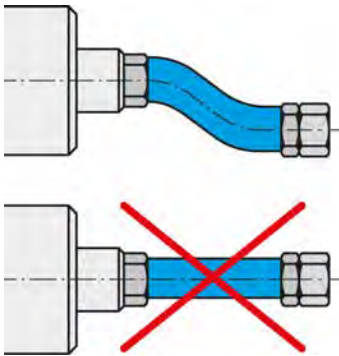

Connect media and cables with a flexible connection.

8.2

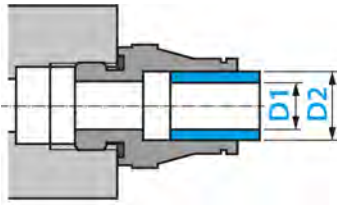

Diameter of media supply line

➔ The nominal size of the media supply lines can be found in the following table:

DN	Medium	D1		D2	
2.8	Compressed air	2.8 mm	$\frac{7}{64}$ "	4 mm	$\frac{5}{32}$ "
4	Compressed air	4 mm	$\frac{5}{32}$ "	6 mm	$\frac{15}{64}$ "
6	Compressed air	6 mm	$\frac{15}{64}$ "	8 mm	$\frac{5}{16}$ "
5.5	Cooling water	5.5 mm	$\frac{7}{32}$ "	8 mm	$\frac{5}{16}$ "
7	Cooling water	7 mm	$\frac{9}{32}$ "	10 mm	$\frac{25}{64}$ "
6	Cooling lubricant	6.4 mm	$\frac{1}{4}$ "	13.4 mm	$\frac{17}{32}$ "
8	Cooling lubricant	8 mm	$\frac{5}{16}$ "	15 mm	$\frac{19}{32}$ "

8.3

Cooling water

8.3.1

Quality of cooling water

Distilled water causes immediate corrosion on bare parts, which is often unnoticeable at first, but later leads to serious corrosion damage.

➔ Do not use pure or distilled water.

Deposits in cooling channels due to unsuitable cooling water prevent the dissipation of heat.

➔ Use cooling water with the following properties:

Drinking water	according to 98/83/EC
Hardness	1-15°dH
PH value	7-9
Additive (corrosion protection)	20% Antifrogen N

8.3.2

Setting the cooling

➔ Observe the following values for liquid cooling:

Hose diameter (*)	Min. DN 5.5
Feed temperature	Min. 20°C
Volumetric flow	Min. 1.5 l/min
Return temperature	Max. 40°C

(*) Use cooling hoses that are impermeable to UV light.

8.4 Compressed air

8.4.1 Air purity classes (ISO 8573-1)

Solid impurities	Class 3 Filter grade at least 5 µm for solids
Water content	Class 4 Max. pressure dew point +3 °C
Total oil content	Class 3 Max. oil content 1 mg/m ³

8.4.2 Setting the sealing air

For guidelines on air quality, see "Air purity classes (ISO 8573-1) [▶ 33]" section.

The adjustment value for the sealing air depends on the hose diameter and length.

- ➔ Hose diameter: DN 4
- ➔ The setting value can be found in the following diagram.
- ➔ To ensure effective control, turn on the sealing air and cooling when turning on the machine. This protects the HF spindle even when it is stationary.

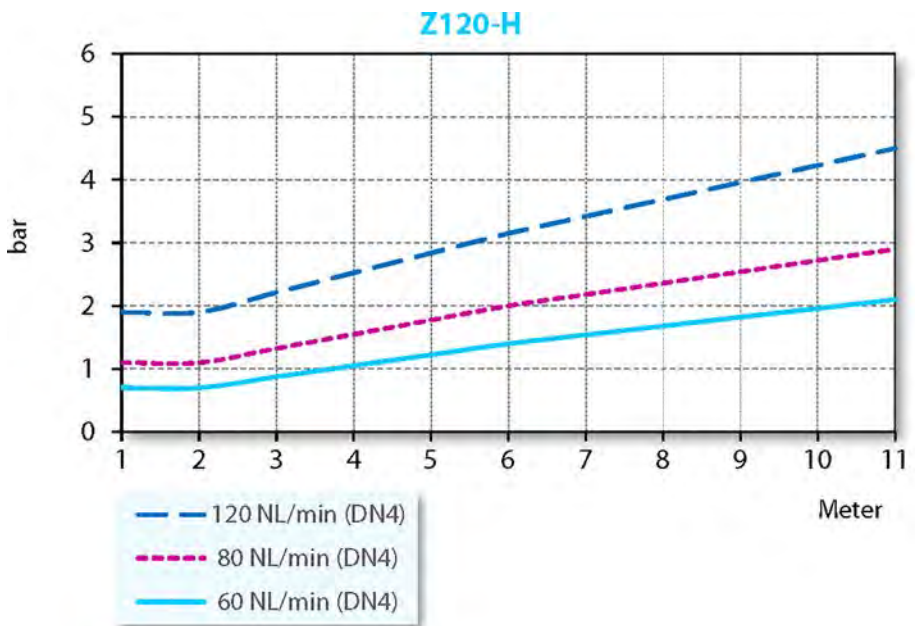

Lowest sealing air supply	Dry machining
Medium sealing air supply	Machining with spray water
Highest sealing air supply	Machining with hose water

8.4.3

For guidelines on air quality, see "Air purity classes (ISO 8573-1) [▶ 33]" section.

Setting values

➔ Keep to the following values:

Taper cleaning	4,5 - 6 bar
Pneumatic system for tool change	≥ 6,0 bar
Internal coolant supply	Max. 80 bar Max. 10 l/min
Cooling lubricant MQL (oil mist)	Max. 10 bar

8.5 Setting the internal coolant supply

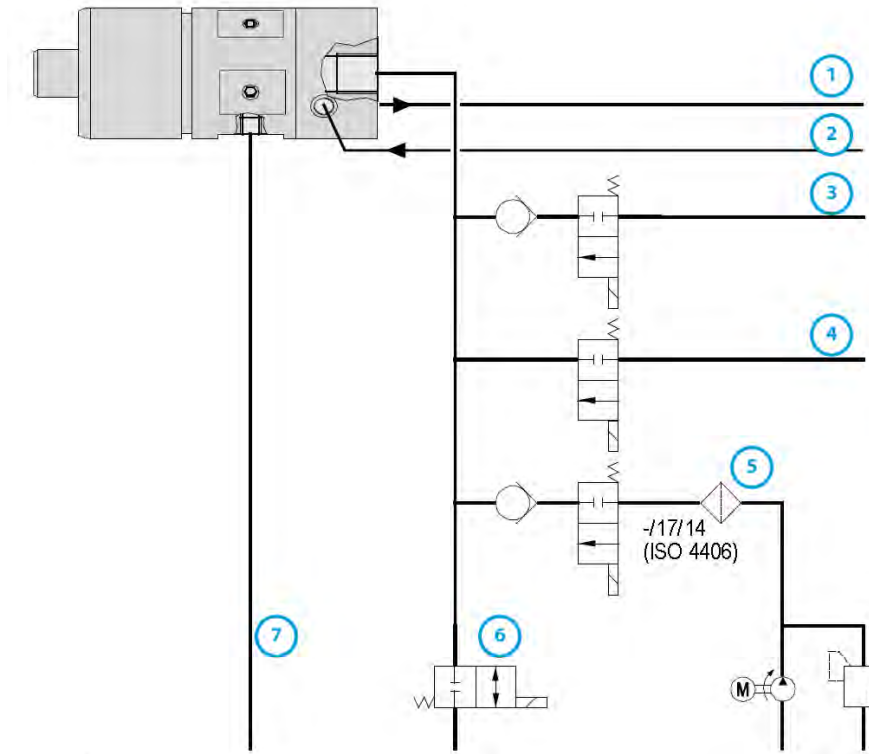

1	Internal cooling (as required)	M5 ≤ 10 bar
2	Internal cooling (as required)	M5 ≤ 10 bar
3	Compressed air	at 0 rpm 10 bar
		uo to 10 000 rpm 5 bar
		above 10 000 rpm No pressure
4	Minimum quantity cooling lubrication	≤ 10 bar
5	Cooling lubricant	≤ 80 bar
6	Vent	G1/8"
7	Leakage	6x M7

- Keep lines short.
- Do not exceed the pressures specified above.
- Avoid pressure pulsation.
 - ↪ Max. ±5 bar.
- Avoid pressure peaks.

Low-pulsation delivery of media (±2 bar) by the pump increases the service life of the cooling lubricant system components and reduces the noise level.

9

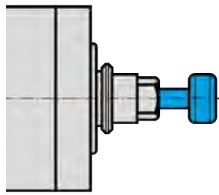

Example of design: Inserting the shank

9.1

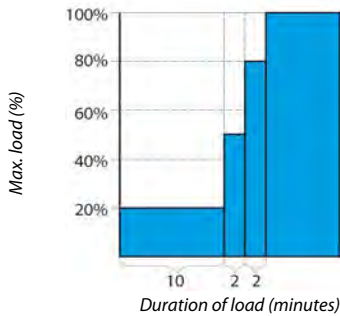

Commissioning

DANGER: Due to flying parts.

If the speed is selected incorrectly, the HF spindle or the tool may be destroyed and their fragments may be flung out.

- ▶ Note the maximum speed for the selected tool.
- ▶ Note the maximum speed for the HF spindle.
- ▶ The maximum permissible speed of the HF spindle for commissioning / processing is always the **lowest** specified speed.

Note: Ensure functionality.

- ▶ Never operate the HF spindle without a clamped tool shank.

If no tool shank is clamped:

- The clamping system is damaged by the centrifugal forces.
- The clamping system is shifted.
- The balance of the HF spindle is affected.
- The bearing is damaged.

- ➞ Turn the shaft of the spindle at least ten times by hand.
- ➞ Before storing and before commissioning only clean the cooling duct with compressed air.

Running-in schedule

- ➞ Put the HF spindle into operation with a clamped tool (without machining) for approx. 10 minutes.
- ➞ The speed in this case should be no more than 20% of the maximum permissible speed for the HF spindle.
 - ⚡ See definition: Max. permissible speed
- ➞ Allow the HF spindle to run for approx. 2 minutes at a maximum of 50% of the maximum permissible speed.
- ➞ Operate the HF spindle for approx. 2 more minutes at a maximum of 80% of the maximum permissible speed.

The HF spindle is now ready for operation.

9.2 Daily start-up

Proceed as follows to preheat the grease lubrication of the bearing and to protect it:

- ➔ Operate the HF spindle with a clamped tool (without machining).
 - ⚡ Approx. 2 minutes.
 - ⚡ At maximum 50 % of the maximum permissible speed.
(See Commissioning [▶ 36] section)

This brings the HF spindle to its operating temperature.

9.3 Shutdown signal

Use the option on the frequency converter of detecting the shutdown signal from the shaft and forwarding this to the machine controller for evaluation.

9.4 Commissioning after storage

- ➔ Do not put the HF spindle into operation until its temperature has adjusted from the temperature of the storage location to the temperature of the usage location.
 - ⚡ The temperature difference between the HF spindle and the usage location should not exceed 10°C.
- ➔ Carry out all steps in the "Maintenance [▶ 44]" section.
- ➔ Operate the HF spindle at a maximum of 50 % of the max. permissible speed for approx. 5 minutes.
 - ⚡ See Commissioning [▶ 36] section
- ➔ Operate the HF spindle for approx. 2 more minutes at a maximum of 80 % of the maximum permissible speed.

This preheats the grease lubrication of the bearing and protects it.

10

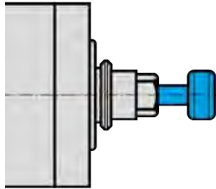

Example of design: Inserting the shank

10.1

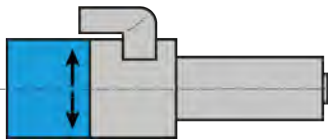

Sample illustration:
Direction of rotation indication

Tool change

CAUTION: Danger of being drawn in by rotating shaft.

If the shaft is still rotating, fingers and hands may be drawn in and crushed.

- ▶ Only change the tool if the shaft is at a standstill.

Note: Ensure functionality.

- ▶ Never operate the HF spindle without a clamped tool shank.

If no tool shank is clamped:

- The clamping system is damaged by the centrifugal forces.
- The clamping system is shifted.
- The balance of the HF spindle is affected.
- The bearing is damaged.

Clockwise and counter-clockwise

The HF spindle clamping system is designed for clockwise and counter-clockwise rotation.

- ↻ Only use tools with the correct direction of rotation for the HF spindle.
- ↻ Only use tool mounts with the correct HF spindle direction of rotation.
- ↻ Set the HF spindle direction of rotation on the FC to match the direction of rotation of the tool / tool mount used.

10.2



Pneumatic taper change

DANGER: Due to flying parts.

The taper cleaning could build up air pressure in the hollow shank taper during the tool taper change. This air pressure flings out the hollow shank taper in the case of sudden release.

- ▶ Only use tool tapers with a centric through-hole.
- ▶ Always switch off the taper cleaning when the hollow shank taper is approx. 1-2 mm away from the contact surface.

Tip: Ensure concentric run-out quality.

- ▶ Keep collet, clamping nut, contact surface, shaft, tool taper, and tool mount clean at all times.
- ▶ Check the tool taper mount.

It must be free of damage and clean when switching to the HF spindle.

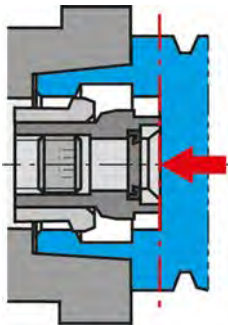

Insert the tool up to the contact surface of the clamping taper.

- ➞ Make sure that the shaft of the HF spindle has come to an absolute standstill.
- ➞ Switch on the compressed air for "cylinder forward".
- ➞ Remove the tool.
- ➞ Clean the inner taper of the tool mount and the inner taper of the shaft with the felt cleaning taper.
- ➞ Insert the tool.
 - ↗ Insert the tool up to the contact surface of the clamping taper.
- ➞ Switch on the compressed air for "cylinder back".
- ➞ Wait for 1-2 seconds after the tool change.
- ➞ Start the HF spindle.

10.2.1

Automatic hollow shank taper tool clamp

We recommend the following values:

- ➞ Coaxiality tolerance when changing the tool.
 - ↗ Coaxiality ($\varnothing G$): 0,8 mm
- ➞ Contact force on clamping taper.
 - ↗ Maximum: 220 N

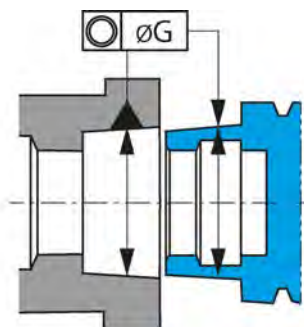

Coaxiality tolerance

10.3

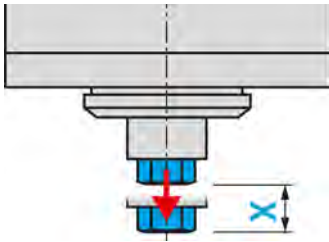

Example of design: Ejection travel

Tool changing station (optional accessory)

During a tool change, the HF spindle moves into the changing station with the clamped tool.

- Note the following values when producing the changing station in order to compensate for the ejection travel (X):

Spring loaded	X = 2 - 5 mm
Spring force	40 - 80 N

10.3.1

pneumatic taper change

During a tool change, the tool mount is pressed out of the shaft by the cylinder.

10.3.2

Installing the changing station

Proceed as follows to install the changing station:

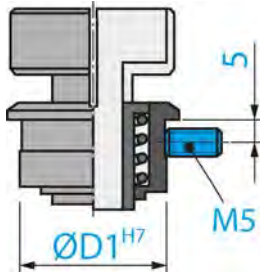

- Drill a hole with a suitable diameter (Ø D1 H7) for the tool mount.
- Add an M5 thread.
- Insert the changing station into the hole.
- Secure the changing station using the threaded spindle (M5).

10.3.3

Maintenance

Before commencing work:

- Check that all surfaces are thoroughly cleaned and free of dust, grease, coolant, machining residues, and metal particles.
- Check that the changing station is free of damage.

10.4 Workflow

10.4.1 Pneumatic workflow

HF spindle shutdown signal from machine controller.
 (Speed = 0 for HF spindle with differential magneto resistor)
 (Frequency = 0 and time delay of at least 2-3 sec for HF spindle without differential magneto resistor)

Caution
 No tool change when shaft rotating.

Tool change at the HF spindle.

Caution
 No rotation without clamped tool.

Tool clamped signal

	Connection No.	Fluid		Compressed air	
		on	off	on	off
Always leave sealing air switched on. Even in the case of a tool change. This prevents dirt or moisture from entering the HF spindle.	3			✓	
Internal coolant supply off.	11	✓			
Taper cleaning on.	4			✓	
Pneumatic system for tool change on. Cylinder forward	7			✓	
Perform tool change.	---				
Taper cleaning off. Switch off when tool taper contact surface is 2 mm away from shaft contact surface.	4				✓
Pneumatic system for tool change on. Cylinder back	8			✓	
Internal coolant supply on.	11	✓			

HF spindle is ready for use.

10.4.2 Electrical workflow

Tool taper	Compressed air on	Clamped	Released	Ejected
Not inserted	Yes	No signal = 0	Signal = 1	No signal = 0
Inserted	Yes	Signal = 1	No signal = 0	No signal = 0
Not clamped	Yes	No signal = 0	No signal = 0	Signal = 1

10.4.3 Signals

Inputs	Description	Signal	Action
Released signal	Cylinder back. Clamping system released. No tool taper inserted in tool mount of HF spindle.	= 0	Do not start HF spindle
Clamped signal	Cylinder back. Clamping system clamped with tool . Tool taper inserted in tool mount of HF spindle.	= 1	Start HF spindle when signal = 1
Ejected signal	Cylinder is extended. Clamping system disengaged. Tool taper inserted in tool mount of HF spindle. Tool taper is not clamped here.	= 0	Do not start HF spindle



Note: Ensure functionality.

The “released” signal shows the user the ready state of the HF spindle in order to ensure safety during operation.

The “released” clamp status is:

- not a permissible operating status
- only permissible during transport and storage

Every idle stroke shortens the service life of the HF spindle.

11

Tools for high speed cutting

**DANGER: Due to flying parts.**

If the wrong direction of rotation is used, the tool is damaged when load is applied. The centrifugal forces cause the broken part to be flung out.

- ▶ Only use tools with the correct direction of rotation for the HF spindle.

**DANGER: Due to flying parts.**

If the speed is selected incorrectly, the HF spindle or the tool may be destroyed and their fragments may be flung out.

- ▶ Note the maximum speed for the selected tool.
- ▶ Note the maximum speed for the HF spindle.
- ▶ The maximum permissible speed of the HF spindle for commissioning / processing is always the **lowest** specified speed.

Note: Unsuitable tool.

Tools without an internal hole are not suitable for internal coolant supply.

- ▶ It is essential to switch off the internal coolant supply if tools without an internal hole are being used for production reasons.

If this is not done, the HF spindle will be damaged or destroyed.

- ↻ Only use tools that are technically sound.
- ↻ Only use tools with a tool shank diameter that corresponds to the inner diameter of the collet. For example, do not use shanks with a diameter of 3 mm in collets for 1/8" (=3.175 mm).
 - ↻ Also see the Technical Specifications [▶ 18] section
- ↻ Only use tool shanks with a diameter tolerance of h6.
- ↻ Do not use tool shanks with a clamping surface (e.g. Weldon).
- ↻ Only use a balanced tool.
 - ↻ DIN ISO 1940, balance grade 2,5 .

12

Maintenance

Only specialist personnel may perform maintenance on the spindle.

The HF spindle must be shut down before any maintenance work.

- Make sure that the shaft of the HF spindle has come to an absolute standstill.
- Before carrying out any work, read the corresponding section of the manual carefully again.
- Observe the manual of the machine in which the HF spindle is installed.
- Observe all safety instructions and safety rules.

12.1

Ball bearings



Note: Foreign matter reduces the service life.

The HF spindle bearings have lifetime grease lubrication. This means that they do not require maintenance.

- ▶ Do not lubricate the ball bearings.
- ▶ Do not apply grease, oil, or cleaning agents to the openings of the HF spindle.

12.2

Daily cleaning

To ensure that the HF spindle functions safely and accurately, all contact surfaces of the HF spindle, the mount for the HF spindle, the tool mount, and the tool holder must be clean.

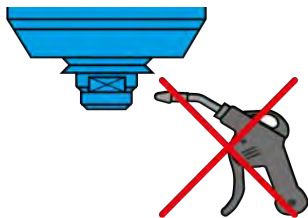

Note: Foreign matter reduces the service life.

- ▶ Do not use compressed air to clean the HF spindle.
- ▶ Do not use ultrasonic cleaning on the HF spindle.
- ▶ Do not use steam jets to clean the HF spindle.

This could cause contamination to enter the bearing area.

12.2.1

Before commencing work

- Check that all surfaces are thoroughly cleaned and free of dust, grease, coolant, machining residues, and metal particles.
- Check that the HF spindle is free of damage.
- If the HF spindle is equipped with sealing air, always switch this on during cleaning.
- Only use a clean, soft cloth or a clean, soft brush for cleaning.

If the HF spindle is equipped with taper cleaning:

- Switch the taper cleaning on for 2-3 seconds after cleaning.

This means that any contamination that is still stuck to the shaft is blown out by the taper cleaning air.

12.2.2 With every tool change

- ➔ Ensure that the tool mount and tool shank are clean.
 - ✚ Remove any soiling.

12.2.3 Every time the clamping device is changed

- ➔ Clean the inner taper of the HF spindle shaft. The inner taper must be free of chips and contamination.
- ➔ Clean the tool taper.

12.3 In the case of storage

If the HF spindle is not required for a prolonged period of time:

- ➔ Before storing and before commissioning only clean the cooling duct with compressed air.
- ➔ Remove all coolant residues.
- ➔ Store the HF spindle in horizontal position.
- ➔ Store the HF spindle so that it is protected from moisture, dust, and other environmental influences.
- ➔ Note the following storage conditions.

Temperature of storage location	+10°C ... + 45° C
Relative humidity	< 50 %

12.4 Weekly maintenance

Visual inspection of the clamping system for:

- ➔ Damage
- ➔ Function

12.5 Monthly maintenance

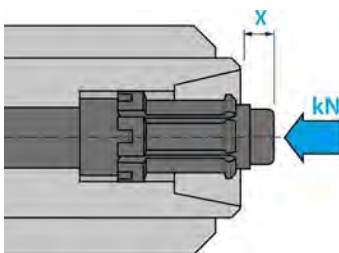

- ➔ Turn the shaft of the HF spindle at least ten times by hand every four weeks.
- ➔ Check dimension X of clamping system
 - ✚ Target dimension: $10,3 \pm 0,1$ mm
- ➔ Check the clamping force of the clamping system
 - ✚ Setpoint: 9,4 - 15,5 kN

If the values are incorrect, send the HF spindle to **Nakanishi Jaeger GmbH** or to a certified service partner for inspection and maintenance.

12.6 Long periods of storage

- ➔ Turn the shaft of the HF spindle at least ten times by hand every three months.
- ➔ Then put the HF spindle into operation with a tool inserted for approx. 10 minutes.
 - ✎ The speed should be no more than 20 % of the maximum permissible speed for the HF spindle. (See Commissioning [▶ 36] section)

12.7 Maximum storage time

The maximum storage time is 2 years.

- ➔ Make sure that all information in the "Long periods of storage [▶ 46]" section is adhered to. This is the only way in which to maintain the functionality of the HF spindle.

13 Dismantling

Proceed as follows to remove the HF spindle:

- ➔ Completely disconnect the power supply.
- ➔ Completely disconnect the media supply (air and liquid).
- ➔ Make sure that the shaft of the HF spindle has come to an absolute standstill.
- ➔ Remove all connections from the HF spindle.
- ➔ Empty the cooling duct of the HF spindle.
- ➔ Remove the HF spindle from the machine.

13.1 Disposal and environmental protection



More than 90% of the materials used in the HF spindle can be recycled (aluminum, stainless steel, steel, copper, etc.)

The HF spindle may not be disposed of with normal domestic waste.

- ➔ Remove all non-recyclable materials.
- ➔ Dispose of the HF spindle as scrap at an approved recycling facility.
- ➔ Follow all rules of the responsible administrative bodies.
- ➔ Do not discharge coolants into wastewater.
- ➔ Dispose of cooling media in accordance with local regulations.

If the HF spindle cannot be dismantled, send the HF spindle to **Nakanishi Jaeger GmbH**. **Nakanishi Jaeger GmbH** shall not assume the costs incurred for shipment and the fees for the recycling facilities.

14 Service and repairs



DANGER: Electric shock.

Electric shock can lead to severe burns and life-threatening injuries.

Take measures to prevent hazards caused by electrical energy (for details refer e.g. to the regulations issued by the VDE and the local energy supply companies).

- ▶ Before commencing work, switch off the power supply of the HF spindle.



Note: Damage due to electrostatic discharge.

Do not touch the electrostatic-sensitive components of the HF spindle.

14.1 Service partners

Only certified service partners may open and repair the spindle. Failure to comply with this voids any warranty claims and compensation claims for damages.

- ➔ The list of partners can be found on the following website.

<https://www.nakanishi-jaeger.com/en/contact/service-partners>

14.2

Malfunctions

The list below can be used to quickly investigate and eliminate faults.

HF spindle not rotating

Cause	Troubleshooting
No power supply	<ul style="list-style-type: none"> <input type="checkbox"/> Check the frequency converter. <input type="checkbox"/> Check the machine. <input type="checkbox"/> Check all electrical connections. <input type="checkbox"/> Check all wires in the motor cable. <input type="checkbox"/> Activate the Start/Reset button.
Thermal protection has been activated	<ul style="list-style-type: none"> <input type="checkbox"/> Wait until the HF spindle has cooled down. <input type="checkbox"/> Check the frequency converter for error messages. If no messages are illuminated, start the frequency converter. (See also "Spindle becomes hot [▶ 48]")
Frequency converter has shut down	<ul style="list-style-type: none"> <input type="checkbox"/> Check the error messages in the frequency converter manual.
Tool change initiated	<ul style="list-style-type: none"> <input type="checkbox"/> Turn off the pneumatic system for the tool change.

HF spindle becomes hot

Cause	Troubleshooting
Insufficient cooling	<ul style="list-style-type: none"> <input type="checkbox"/> Check the power of the chiller. <input type="checkbox"/> Check the water level of the chiller. <input type="checkbox"/> Check the connections and the cooling hoses. <input type="checkbox"/> Check the cooling circuit. <input type="checkbox"/> Check the chiller for error messages.
Phase missing	<ul style="list-style-type: none"> <input type="checkbox"/> Check all wires in the motor cable for cable breaks.
Machining too heavy	<ul style="list-style-type: none"> <input type="checkbox"/> Check the rotational direction of the HF spindle. <input type="checkbox"/> Check the rotational direction of the tool. <input type="checkbox"/> Check the tool for damage. <input type="checkbox"/> Reduce the machining load intensity.
Frequency converter incorrectly set	<ul style="list-style-type: none"> <input type="checkbox"/> Compare the values for the HF spindle with the set values on the frequency converter.

HF spindle becomes loud

Cause	Troubleshooting
Tool unsuitable	<ul style="list-style-type: none"> <input type="checkbox"/> Only use balanced tools. (Also see the "Tools for high speed cutting [▶ 43]" section.) <input type="checkbox"/> Check the tool for damage. <input type="checkbox"/> Replace damaged tool.
HF spindle is not clamped truly or is distorted	<ul style="list-style-type: none"> <input type="checkbox"/> Only use spindle holders from the original accessories or holders produced according to the tolerances specified by Nakanishi Jaeger GmbH.
HF spindle clamped too tightly	<ul style="list-style-type: none"> <input type="checkbox"/> Only tighten the clamping screws of the spindle holder manually. <input type="checkbox"/> Do not use technical aids to clamp the HF spindle.
Bearings damaged	<ul style="list-style-type: none"> <input type="checkbox"/> Contact Nakanishi Jaeger GmbH service.

No automatic tool change

Cause	Troubleshooting
Contamination	<ul style="list-style-type: none"> <input type="checkbox"/> Remove all contamination between the tool taper and shaft of the HF spindle. (Observe all points in the "Tool change [▶ 38]" and "Maintenance [▶ 44]" sections.)
Collet does not open	<ul style="list-style-type: none"> <input type="checkbox"/> Check the electrical connection of the cylinder. (Observe all points in the "Tool change [▶ 38]" and "Maintenance [▶ 44]" sections.)
No ventilation	<ul style="list-style-type: none"> <input type="checkbox"/> Check whether both connections of the dual-action cylinder are connected. <input type="checkbox"/> Check whether the cylinder is taking in air.

Sensor does not send any signals

Cause	Troubleshooting
No connection to sensor	<ul style="list-style-type: none"> <input type="checkbox"/> Check the lines and connections.
Incorrect tool position	<ul style="list-style-type: none"> <input type="checkbox"/> Check whether the tool is clamped correctly.
Incorrect tool insertion position	<ul style="list-style-type: none"> <input type="checkbox"/> Contact Nakanishi Jaeger GmbH service.

**HF spindle vibrates/
oscillates**

Cause	Troubleshooting
Tool unsuitable	<input type="checkbox"/> Only use balanced tools. (Also see the "Tools for high speed cutting [▶ 43]" section.) <input type="checkbox"/> Check whether the tool is suitable for the application. <input type="checkbox"/> Check the tool for damage. <input type="checkbox"/> Replace damaged tool.
Contamination	<input type="checkbox"/> Remove all contamination between the tool taper and shaft of the HF spindle. (Observe all points in the "Tool change [▶ 38]" and "Maintenance [▶ 44]" sections.)
Frequency converter incorrectly set	<input type="checkbox"/> Compare the values for the HF spindle with the set values on the frequency converter.
Machining too heavy	<input type="checkbox"/> Reduce the machining load intensity.
Mounting screws are loose	<input type="checkbox"/> Tighten the screws securely.
HF spindle damaged	<input type="checkbox"/> Contact Nakanishi Jaeger GmbH service.

If the error is not rectified after checking all of the points, contact the relevant service partner.

- ➔ Request the accompanying note for the repair from the service partner.
- ➔ Check the manual of the machine.
- ➔ Contact the manufacturer of the machine.

15 Declaration of Incorporation

The safety instructions of the product documentation supplied must be observed.

Under the EC Machinery Directive

Nakanishi Jaeger GmbH

SF-Elektromaschinenbau

Siemensstr. 8

D-61239 Ober-Mörlen

Tel. +49 (0) 60029123 -0

hereby declare that the product,

Product	High Frequency Spindle
Type	Z120-H824.11 K1RW2V
Serial no.	See last page of manual

as far as possible from the supplied, complies with the essential requirements of the Machinery Directive 2006/42/EC.

Sections of the Machinery Directive have been applied: 1.1.1; 1.1.2; 1.1.5; 1.3.2; 1.3.4; 1.5.1; 1.5.2; 1.5.4; 1.5.5; 1.5.6; 1.5.8; 1.5.9; 1.6.4; 1.6.5; 1.7.1; 1.7.1.1; 1.7.2; 1.7.3; 1.7.4;

The incomplete machinery in its standard design complies furthermore with the following applicable regulations:

Applicable harmonized standards	DIN EN ISO 12100 Safety of machines
---------------------------------	--

The machinery is incomplete and must not be put into service until the machinery into which it is to be incorporated has been declared in conformity with the provisions of the Machinery Directive 2006/42/EC and any other applicable regulations.

We at Nakanishi Jaeger GmbH agree to submit the special documents for incomplete machines to national authorities upon request.

The special technical documentation referred to in Annex VII, Part B, belonging to the machine has been created.

Person who is authorized to compile the documents listed in Annex VII, Part B:

Nakanishi Jaeger GmbH

Ober-Mörlen, 06.11.2024



Nakanishi Jaeger YouTube channel

Scan this QR code with any QR code scanner.



Nakanishi Jaeger GmbH

Siemensstraße 8
61239 Ober-Mörlen
GERMANY

☎ +49 (0)6002-9123-0
✉ sales@anakanishi-jaeger.com
www.nakanishi-jaeger.com

Jaeger Spindles North America, Corp.

6611 Bay Circle, Suite 165
Norcross, GA 30071
USA

☎ +1 (770) 674-4480
✉ office@jaegerspindles.com
www.nakanishi-jaeger.com/en

Serial number



Type **Z120-H824.11 K1RW2V**

Item no. **10408022**

Revision 07 Date 06.11.2024

Language EN

